

Rationalization of construction by employing slipforming to prestressed concrete outer tank for LNG storage

Shunsuke Ohnishi, Takeyoshi Nishizaki
Engineering Department
Osaka Gas Co., Ltd.
Japan

1. Introduction

LNG is a clean and environment-friendly energy source. The demand of LNG is increasing as an energy source for the electric power supply by thermal power stations, and is expected to increase the demand in the future.

Osaka Gas planned to build a full containment LNG tank that has the world's largest capacity 230,000 m³ in Senboku Receiving Terminal. And we applied the slipforming to construct a prestressed concrete outer tank for the first time in Japan aiming at rationalization of construction. The slipforming is a method to construct the outer tank by placing concrete continuously into formwork that is raised progressively upward with jacks. This method has been used to construct vertically-tall concrete structures such as chimneys and towers. However, it was the first time that the slipforming was applied to such a large-scale cylindrical tank.

In order to construct the outer tank having a circumference of approximately 280m at constant speed, the concrete shall be required for the following characteristics; the flowability to spread thinly and broadly and to pour with supportive compaction; the early strength development that the concrete has achieved sufficient strength to carry its own weight at form removal; and the resistance to carbonation and ingress of chloride ions for long-term exposure. Besides, the concrete placing and assembling work of reinforcing bars and sheaths as materials to form ducts for the prestressing must be executed simultaneously along with the slipforming formwork that is raised progressively upward. Therefore, the establishment of efficient construction procedure and the measuring system in real-time of position, shape and concrete members including the embedment are required for continuous construction the outer tank continuously while meeting the required accuracy.

This paper reports the outline of outer tank construction by slipforming and the high-accuracy positioning procedure of anchors for attaching liners on the inner wall of outer tank, which is specific to LNG tanks in Japan. Also, the result of durability test for concrete structure against carbonation and chloride ions attack is reported.

2. Outline of outer tank construction

Figure 1 represents the sectional drawing of a full containment tank with a capacity of 230,000 m³. The basic specifications are shown in Table 1. The prestressed concrete outer tank is a cylindrical shell structure with 90.8 m in external diameter, 800 mm in wall thickness, and 43.6 m in height designed to contain the entire amount of stored LNG in case of accidental leakage. The compressive strength of outer tank concrete is set in four levels based on the load (liquid pressure) to act under the different loading conditions of each level: 60 N/mm², 40 N/mm² and 30 N/mm². In this project, the outer tank 40 m in height is planned to be constructed in 20 days by placing concrete at a rate of 10 cm per hour. The outer tank is cylindrical with a wall thickness of 80 cm and perimeter of 280 m. Concrete is therefore planned to be placed in four separate blocks with assembling work of reinforcing bars and sheaths, the sliding speed of slipforming equipment for 2 m per day. Conventionally, the outer tank has been constructed by the jumping form method. In this method, the outer tank is divided into 10 lifts by each

approximately 4 m heightwise. Formworks and scaffoldings are reassembled or disassembled on a lift system with a large crane at each lift. It takes a month to reassemble formworks and scaffoldings on each lift, so that it requires 10 months to complete the construction of a 40 m outer tank.

On the other hand, the slipforming is a method to construct the outer tank by placing concrete and assembling reinforcing bars simultaneously while the slipforming equipment including frameworks and scaffoldings is raised progressively upward with jacks along the outer wall. By the method, we can shorten the construction period of a 40m outer tank construction in only 20 days because there is no need to form concrete joints and reassemble formworks and scaffoldings at each lift.

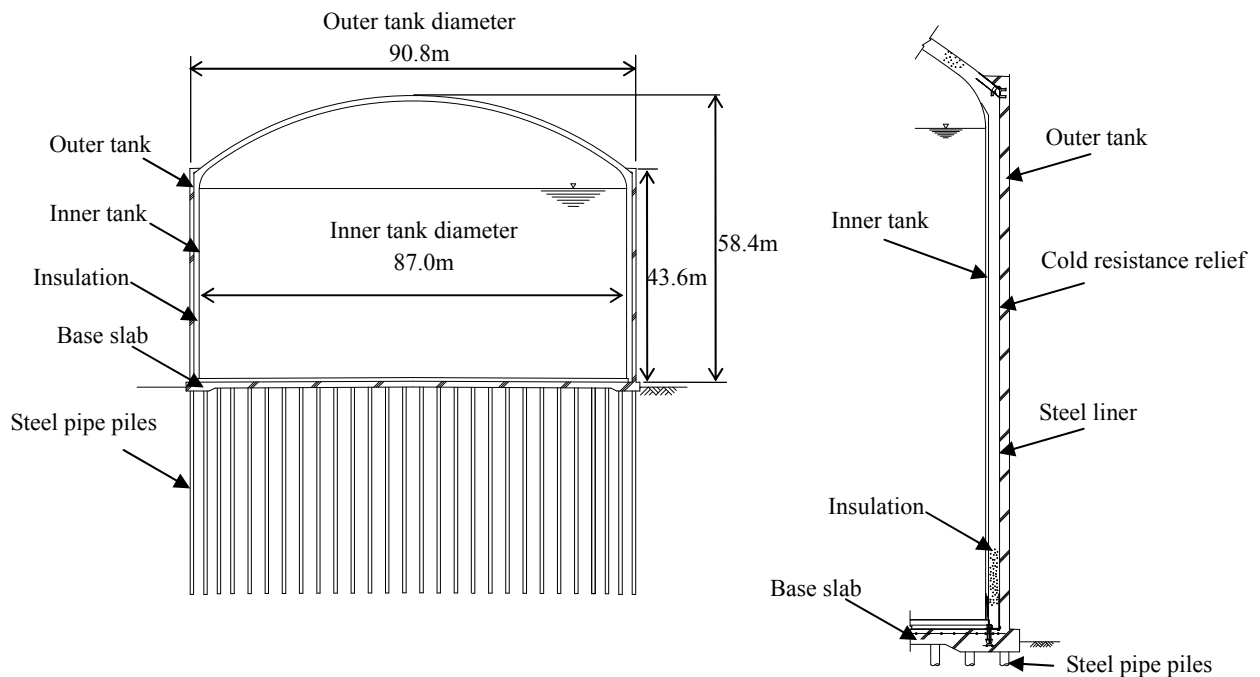

Figure 1. Sectional drawing of a full containment tank with a capacity of 230,000 m³

Table 1. Basic specifications of LNG tank

Item	Specifications
Inner tank	Material: 7% Ni-TMCP steel Inner diameter: 87.0m Liquid height: 38.7m
Outer tank	Material: Prestressed concrete with steel liner Inner diameter: 89.2m, Thickness: 0.8m Design standard strength: 30, 40, 60N/mm ² Prestressing: Freyssinet method Mono Group system 27K15 (circumferential direction), 19K15 (vertical direction)
Base slab	Material: Reinforced concrete Design standard strength: 30,40N/mm ² Diameter 92.4m, Thickness: 1.2m to 1.8m
Piles	Material: Steel pipe Diameter: 700mm, Thickness: 13mm, 10mm, 9mm Number of piles: 746

3. Outline of slipforming and procedure of outer tank construction

Figure 2 shows the cross-section view of the slipforming and Figure 3 shows the outline of outer tank construction by the slipforming. The slipforming equipment comprises: yokes (straight side steel frames) for keeping formworks; 15ton hydraulic jacks for raising system upward; jacking rods for supporting reaction force to lift up the system; rails and a carrier bucket (capacity of 0.5m^3) for carrying concrete to a placing position in a horizontal direction. Basically, the slipforming system is raised progressively upward for 15cm per 90 minutes, and the concrete is placed simultaneously with assembling reinforcing bars and sheaths along with the rise of slipforming equipment. Therefore, we decided the height of concrete placing to 15cm/layer and planned to place concrete at every 90 minutes. Also, we provided the ready-mixed concrete for 24-hour continuous production from a batcher plant adjacent to the site.

In order to facilitate slipforming efficiently for outer tank, it is important to apply the construction technique that can manage the speed of works efficiently as well as to provide a clear chain of command. We assigned 4 work parties, which were in charge of assembling reinforcing bars and sheaths and placing concrete in each work area. Also, we provided a chain of command that is organized by; a person in charge of formwork elevation accuracy; a person in charge of concrete production; 4 work party leaders; and a construction supervisor. This chain of command linked all persons to the construction supervisor and helped to collect the information to carrying out the construction work as planned.

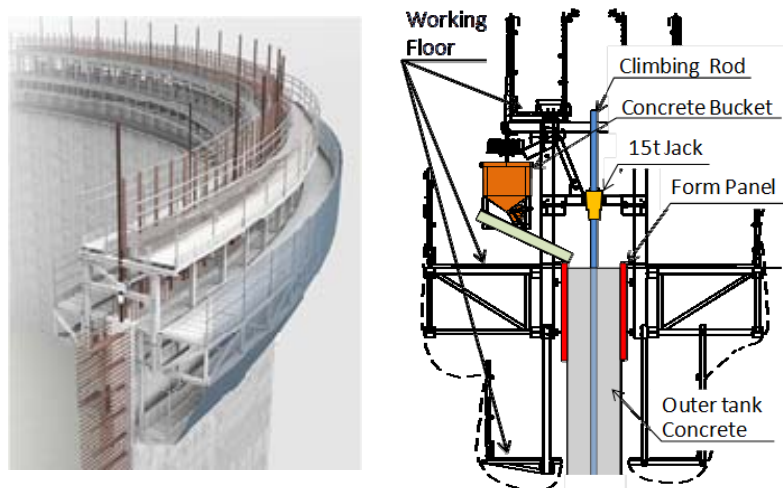

Figure 2. Image and of cross-section view of the slipforming

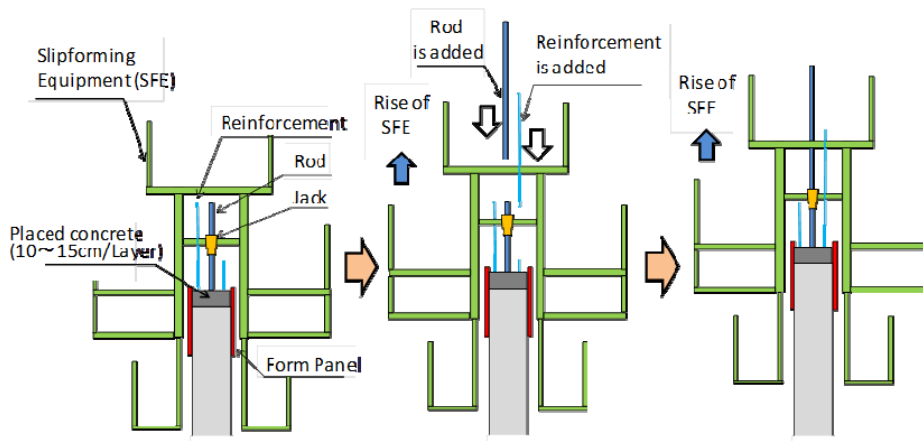

Figure 3. Outer tank construction by slipforming

4. Technical development - Installation of anchors for steel liners -

On the inner surface of the outer tank, steel liners of 3.2mm thickness are installed. The liners retain N₂ gas, which is inactive gas filled up between inner and outer tanks, and to prevent moisture ingress having an adverse impact on cooling effect.

The liners are attached by anchors that are installed on the inner surface after placing concrete. The anchors are embedded in the inner wall of the outer tank with high-accuracy positioning along with the rise of slipforming equipment. About 150 anchors are needed to be smoothly-embedded and arranged on the surface of the concrete of outer wall at the same height of circumferential location. We have achieved a new solution by developing “Settled form construction method (insert type of formwork units with anchors)” shown in Picture 1.

The anchors are arranged at the required positions on the wooden formwork units. The formwork units are inserted to the guide frame of slipforming equipment. The anchors are set and hold at the intended position by the formwork units when the slipforming system is raised progressively upward. Using the formwork units, we could shorten the time for installation of anchors substantially.

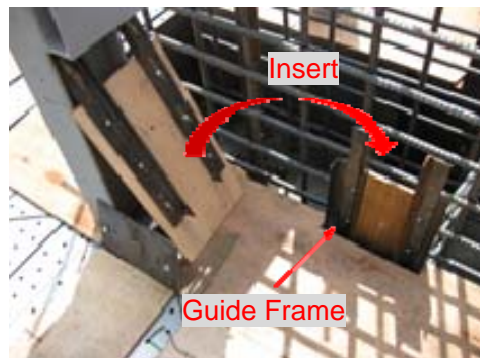

5. Evaluation of durability of concrete for early form removal

The slipforming can significantly reduce the time for concrete placing and form removal. However, there is concern that a shortened curing period of concrete may have an adverse effect on forming performance and durability of the outer tank.

We implemented exposure tests and durability studies on test specimens having the same composition and concrete thickness used for this outer tank. Then we verified the applicability of slipforming related to the development of compressive strength at early form removal, the influence of concrete strength and curing period on porous structure and the infiltration characteristics of salt content that causes aging degradation.

In the durability study of concrete under the influence of early form removal, we used the Model specimens (thickness: 80 cm) that were fabricated by two concrete compositions, 30N/mm² (Blast-furnace cement) and 40N/mm² (Moderate heat cement). The Model specimens removed from the formwork were exposed to the outdoor environment up to an age of 3 months after 12 hours of forming in the same condition as the actual outer tank construction. Then the cores of the test specimens were sampled for accelerated carbonation test and chloride penetration tests. These tests were operated under the normal ambient temperature.

Table 1 shows the carbonation rate coefficients and chloride ion diffusion coefficients obtained from accelerated tests using the cores sampled from the test specimens. These coefficient values were calculated

according to the Japanese specifications about the concrete structure, “the Standard Specification for Concrete Structure” published by Japan Society of Civil Engineers. The carbonation rate coefficient were kept at low levels necessary for ensuring durability, or well below 8 (mm/√year) satisfying the required durability. Therefore, we confirmed that the possibility of causing carbonation-induced steel corrosion is very low despite early form removal. Durability verification was conducted based on the chloride ion diffusion coefficients given in Table 1 and the chloride ion content near the concrete surfaces determined from cores drilled from an outer tank of an existing full containment tank in Senboku terminal. Typical results are shown in Figure 2. Durability against chloride attack was ensured throughout the required service life of 50 years even when formwork was removed at early ages.

Table 1. Evaluation of coefficient of carbonation velocity and diffusion coefficient of chloride ion

Curing method	Accelerating test of carbonation (Accelerating period of 3 months)		Coefficient of carbonation velocity in site (mm/√year)	Salt immersion examination (Accelerating period of 3 months)					Diffusion coefficient of Chloride ion (cm ² /year)
	depth of carbonation (mm)	Coefficient of carbonation velocity in accelerating test (mm/√week)		Chloride ion concentration (kg/m ³)					
				Range from the test specimen surface (mm)					
				0~20	20~40	40~60	60~80	80~100	
No-Curing	4.7	1.3	0.73	9.2	0.2	0.2	0.1	0.1	0.35
Curing agent A	3.2	0.9	0.50	5.2	0.2	0.1	0.1	0.1	0.13
Curing agent B	12.1	3.4	1.87	5.6	0.2	0.2	0.2	0.1	0.15
Sealed curing	0.0	0.0	0.00	5.7	0.2	0.2	0.2	0.1	0.16

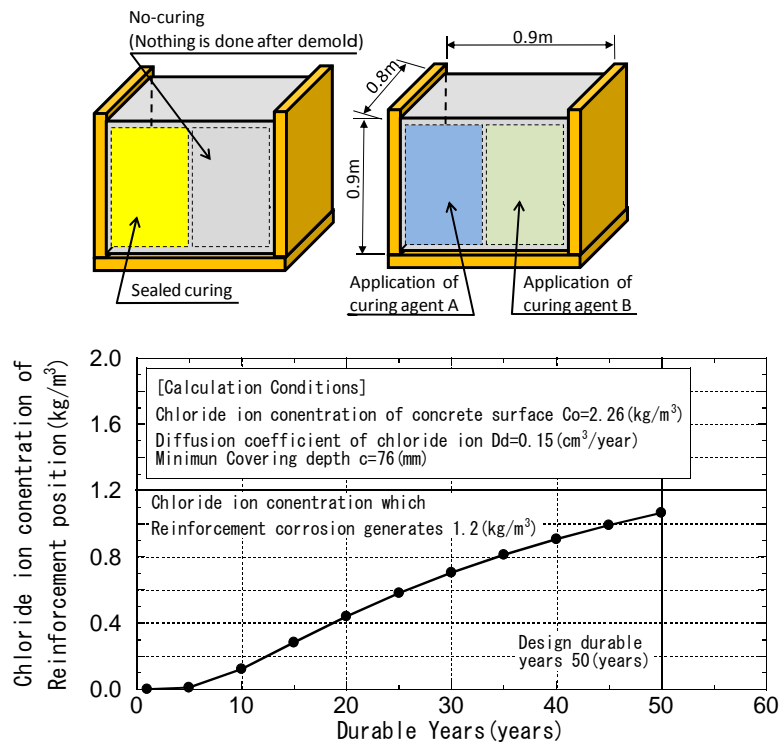
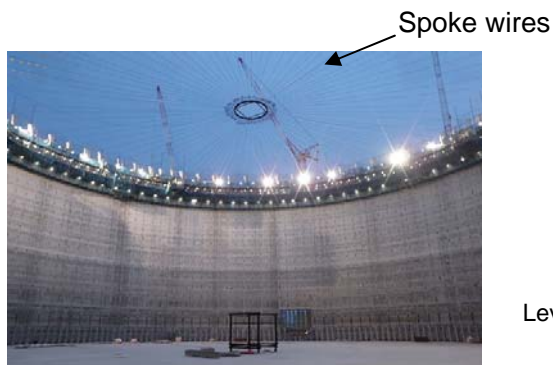

Figure 4. The durability collation result of reinforcement corrosion

6. Establishment of construction accuracy

Conventionally, the roundness of concrete surface of the outer tank has been measured by the level transit equipment. However, measuring devices are not applicable because the slipforming equipment is raised progressively upward. Therefore, we used a laser vertical detector and a laser range finder to measure center segregation, horizontality, roundness and rotation of the concrete structure in order to meet the sufficient accuracy in continuous construction as shown in Figure 3. The measured data were collected under centralized control at the operation room, and the data were reflected to control of the adjustment mechanism such as hydraulic jacks and spoke wires for meeting the high- accuracy in real-time.

Picture 2 shows a part of the adjustment mechanism, called as spoke wires, which adjust roundness of whole slipforming equipment by wire tension and keep the construction accuracy.



Picture 2. Spoke wires
(the adjustment mechanism)



Picture 3. Inside of the outer tank

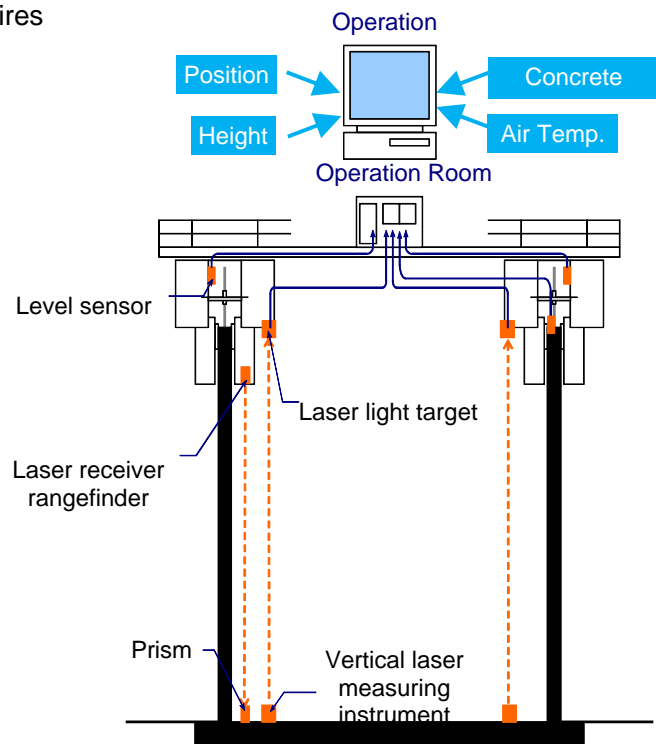

Figure 5. Measuring devices

7. Result of construction

The 40m height outer tank was built up for only 20 days by the slipforming. The concrete was placed for 10cm per an hour in night and day continuously. This method contributed to shortening for about 9 months of the total construction period for the outer tank and reducing the construction cost for about 20% compared with the conventional method. Additionally, the congestion with the mechanical work operated successively was mitigated and the safety for the construction work was also improved.

8. Conclusion

The construction of outer tank was launched by the slipforming on April 2013, and completed in only 20 days as planned. Picture 4 shows the overview image of the outer tank in construction. Based on the valuable experiences and accomplishments in this work, we will promote further rationalization of concrete construction as well as improvement of the slipforming method as a standard for constructing the outer tank of the full containment LNG tank.



April 12th, 2013



April 19th, 2013



May 2nd, 2013

Picture 4. Result of slipforming construction