

Gas and low carbon economy

Gérard Moutet
TOTAL

IGU
Durban, december 4th 2011



Gas has a growing place in our vision of the future energy mix

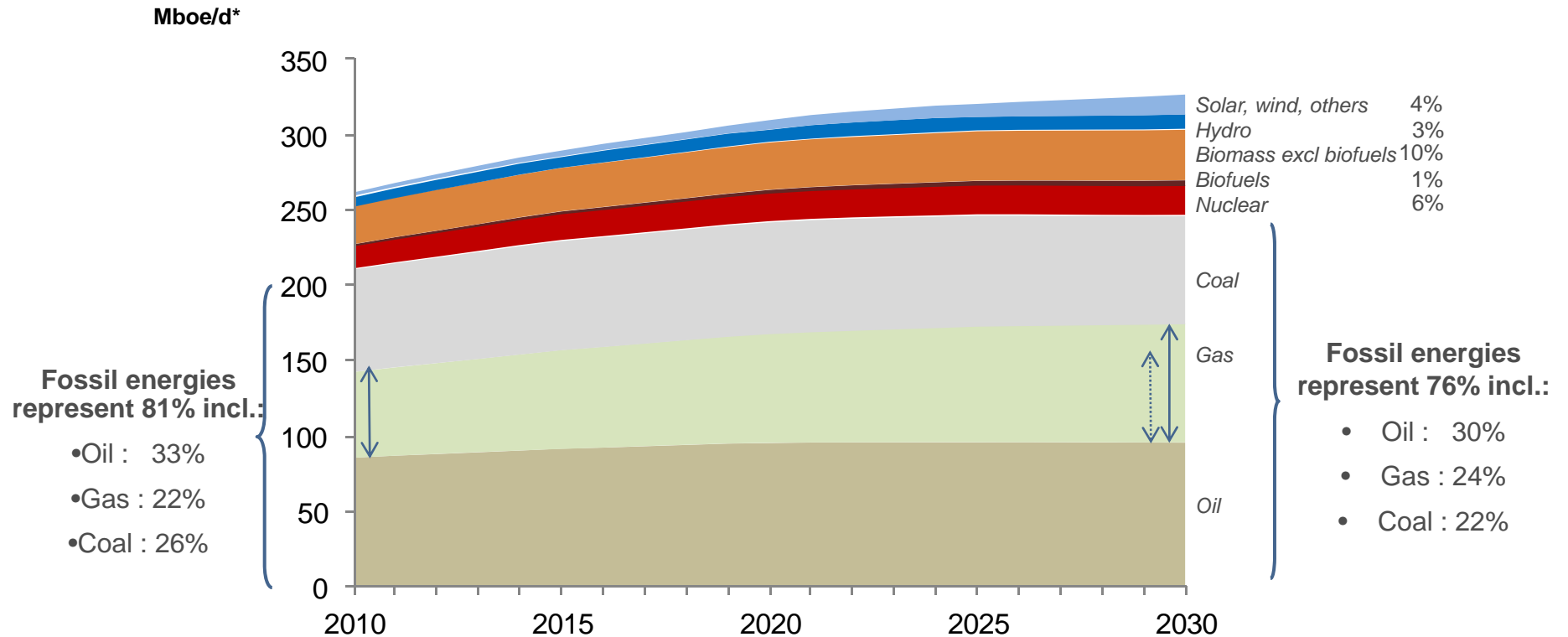

Efficient CO2 emissions management and diversification of energy supply are key issues

* Million barrels of oil equivalent per day.
Source: Total estimates after Fukushima accident

Significant gas resources yet to be produced ...

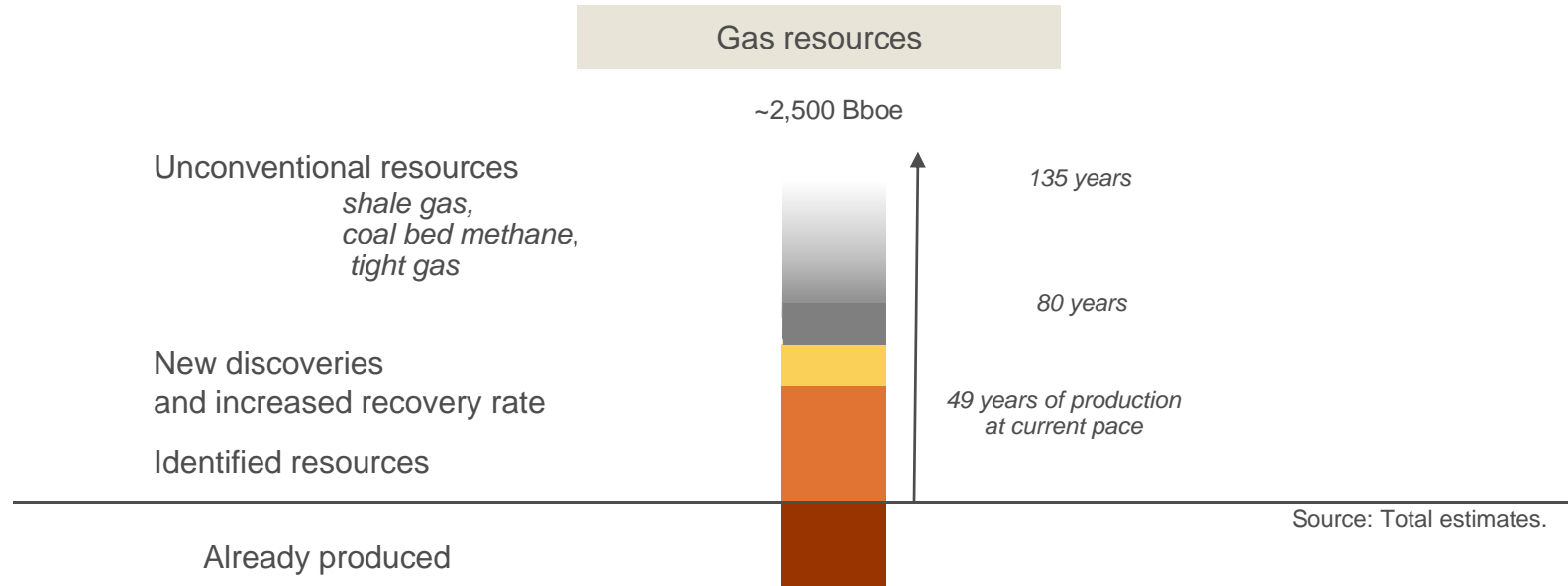

... that will allow lower GHGs emissions

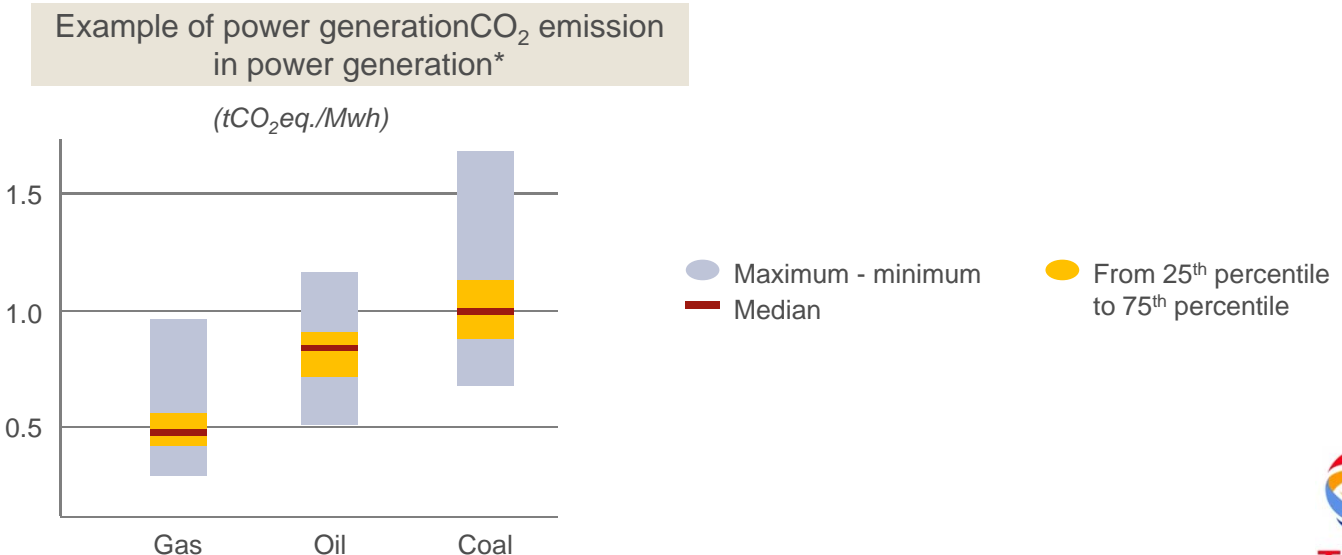

* source: IPCC, Special report on Renewable Energy, 2011

TOTAL anticipate a growing part of gas in its production ...

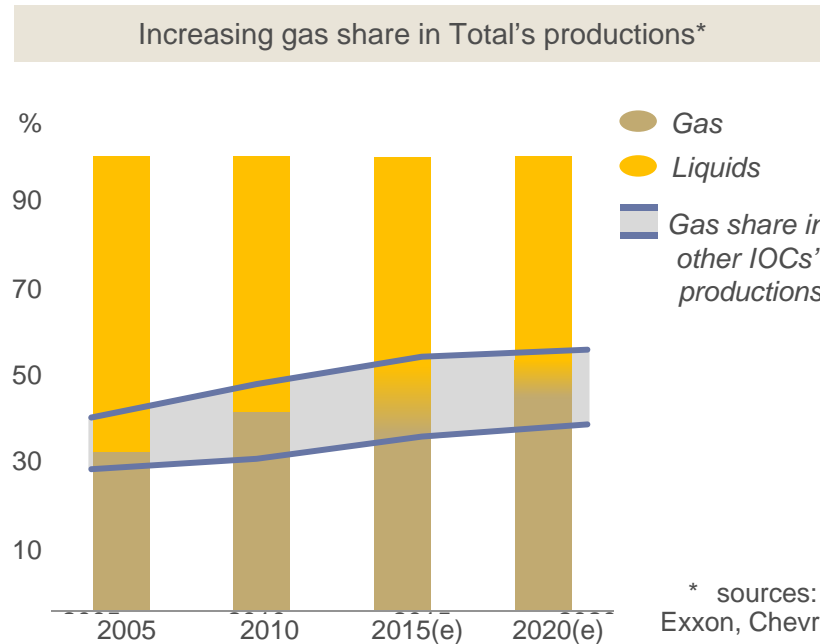

... and has a coherent strategy to maximize gas valorization

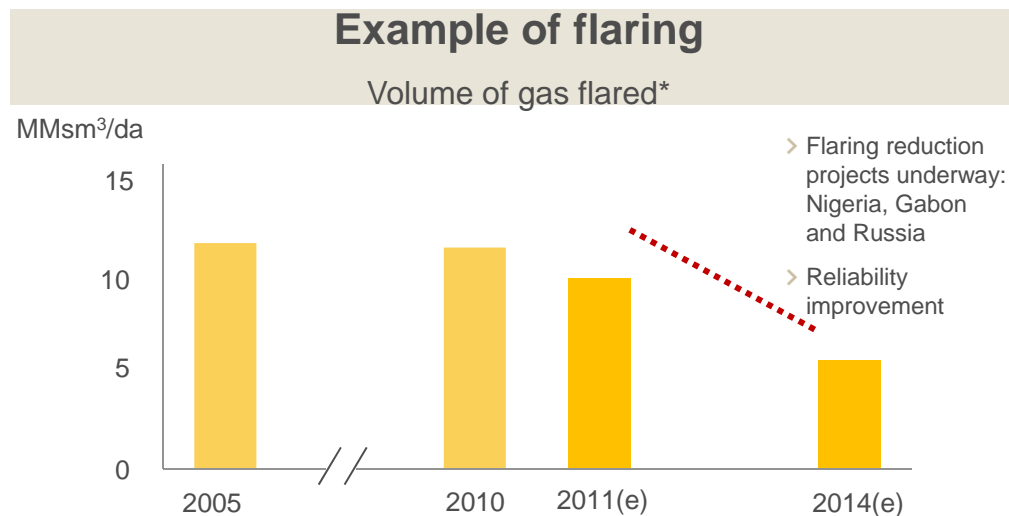

With growing international LNG exchange, Gas is becoming a global solution ...

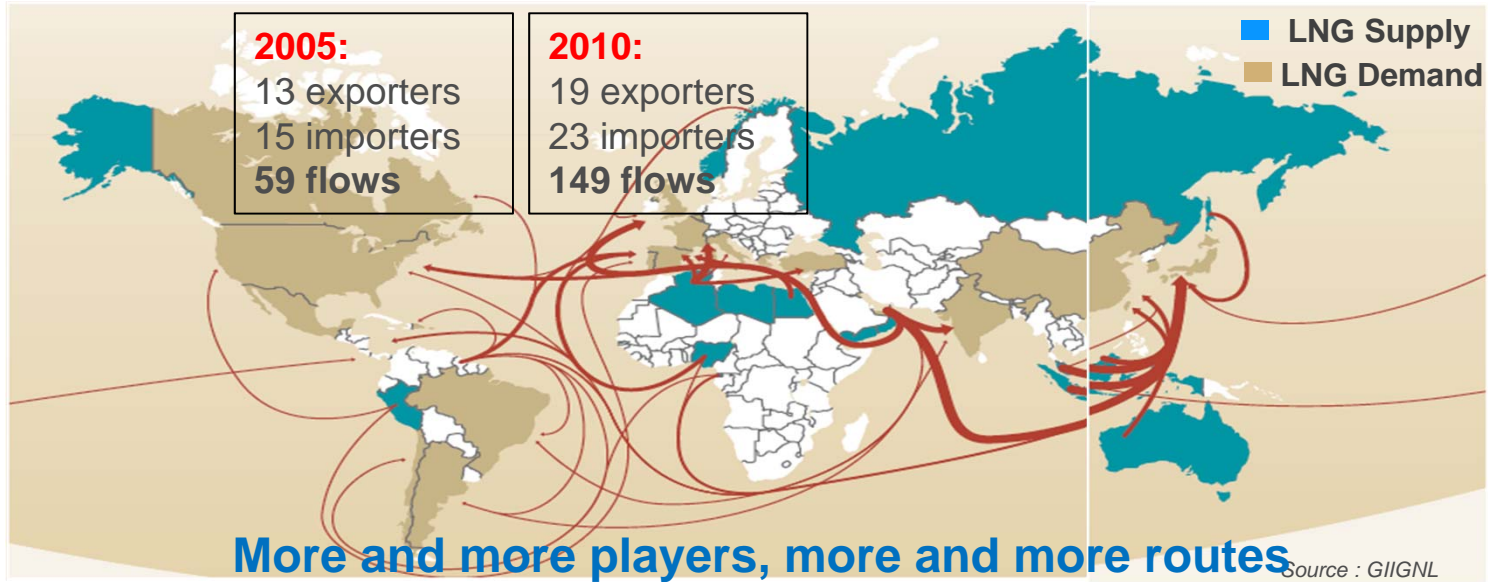

... and TOTAL positioned itself among global leaders in LNG

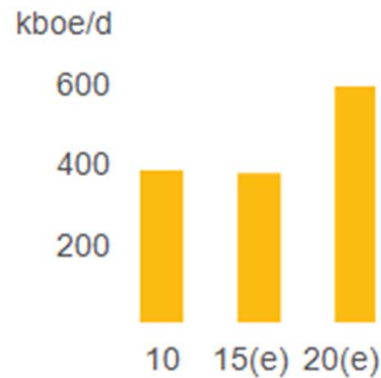

Gas has also synergies with renewable intermittent energy

Example of Total Shams project in Abu Dhabi

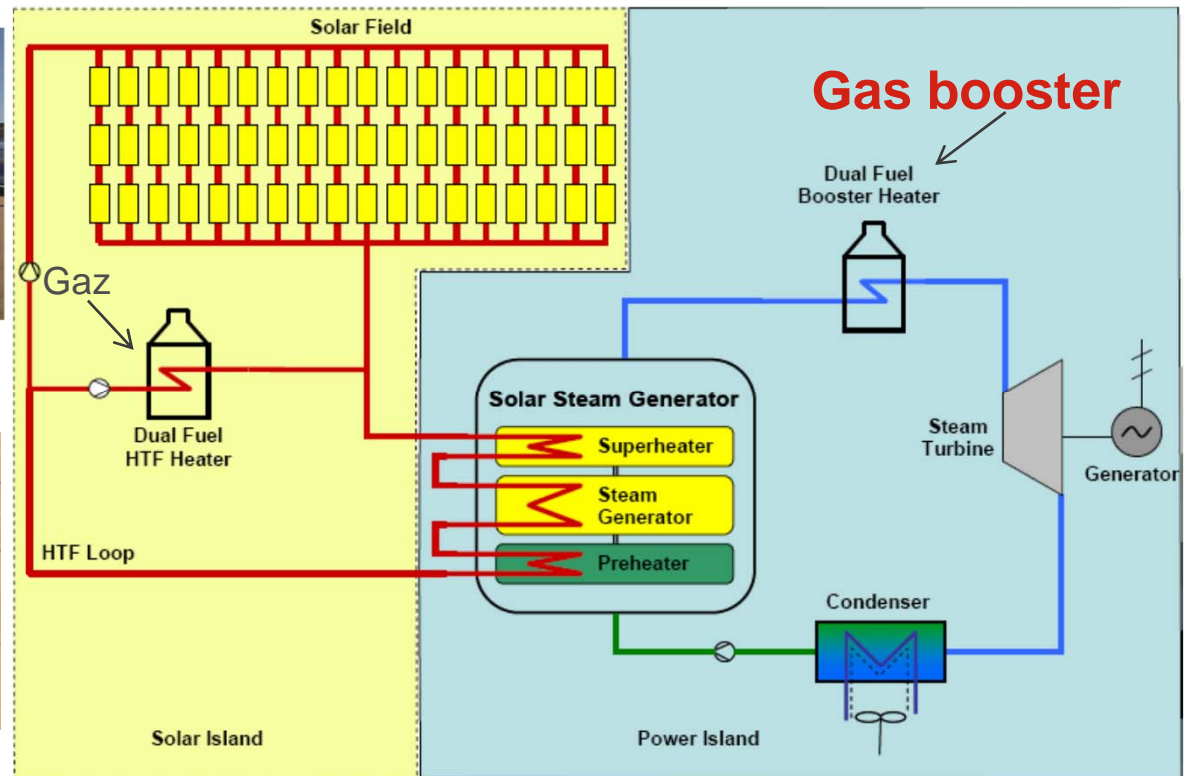

Gas is a key transitional energy toward a low carbon economy, with ample resources to be produced.

Thank you

